ISTRUZIONI PER L'INSTALLAZIONE E LA MANUTENZIONE (IT)
INSTRUCTIONS FOR INSTALLATION AND MAINTENANCE (GB)
INSTRUCTIONS POUR L'INSTALLATION ET LA MAINTENANCE (FR)
INSTALLATIONS- UND WARTUNGSANLEITUNGEN (DE)
INSTRUCCIONES DE INSTALACIÓN Y MANTENIMIENTO (ES)
GEBRUIKS- EN ONDERHOUDSAANWIJZINGEN (NL)
POKYNY K MONTÁŽI A ÚDRŽBĚ (CZ)
INSTRUÇÕES DE INSTALAÇÃO E MANUTENÇÃO (PT)
KURMA VE BAKIM BİLGİLERİ (TR)

E.SWIM
E.PRO



INDEX

KEY	33
IMPORTANT WARNINGS AND SAFETY RECOMMENDATIONS	33
RESPONSIBILITY	36
1 GENERAL	36
1.1 Description	36
1.2 Technical characteristics	37
2 INSTALLATION.....	37
2.1 Hydraulic connections	37
2.2 Electrical connection to the supply line.....	38
2.3 Electrical connections for auxiliary inputs and outputs	39
3 THE OPERATOR PANEL	40
3.1 Keyboard and Display	40
3.2 Main page of the display (<i>homepage</i>)	41
4 Commissioning	42
4.1 Priming	42
4.2 Guided configuration (WIZARD)	42
5 SWITCHING ON AND USING THE PUMP	43
5.1 Operating mode	43
5.1.1 Regulating modes	43
5.1.2 Command modes	44
5.2 Rapid starting and stopping of the pump ("Manual" mode)	45
5.3 Rapid changing of the setpoint and of the pre-set parameters	46
5.4 Advanced use ("Auto" mode)	46
6 SELECTING THE PREFERRED modes (menu)	47
6.1 Menu access and navigation.....	47
6.1.1 Appearance and opening page of the menu	47
6.1.2 Access to a sub-menu	47
6.1.3 Changing a parameter in the menu	48
6.2 Menu structure.....	50
6.2.1 Settings.....	51
6.2.1.1 WIZARD (<i>loaded from the menu</i>)	51
6.2.1.2 Languages	51
6.2.1.3 Day & Time	51
6.2.1.4 Unit of Measure	51
6.2.1.5 Pump Limits	52
6.2.1.6 Screen adjustment.....	52
6.2.1.7 Password	52
6.2.2 Set Points 1-4	53
6.2.3 Set Points 5-8	53
6.2.4 Quick Clean	54
6.2.5 Timers	54
6.2.5.1 Timer Settings.....	55
6.2.5.2 Timer daily summary	55
6.2.6 External Control	56
6.2.6.1 Configuration of the Inputs.....	56
6.2.6.2 Configuration of the Outputs.....	56
6.2.7 Priming.....	56
6.2.8 Antifreeze (Protection against water freezing in the pump).....	57
6.2.9 Anti-Lock (Protection against mechanical blocking of the pump).....	58
6.2.10 Fault History.....	58
7 PROTECTION SYSTEMS – LOCKS (FAULT)	59
7.1 Manual reset of error conditions.....	59
7.2 Automatic reset of error conditions	59
7.3 Viewing the block history	59
8 Factory settings	60
8.1 Restoring the factory settings.....	61
9 Troubleshooting.....	61
10 Maintenance	62
11 DISPOSAL.....	62
12 GUARANTEE	62

KEY

The following symbols have been used in the discussion:



Situation of general danger. Failure to respect the instructions that follow may cause harm to persons and property.



Situation of electric shock hazard. Failure to respect the instructions that follow may cause a situation of grave risk for personal safety.



Notes and important remarks.

IMPORTANT WARNINGS AND SAFETY RECOMMENDATIONS

This manual concerns the product DAB E.SWIM / E.PRO.

GENERAL RISK FACTORS



Before installation, carefully read this manual which contains important information for use of the product. This document must be kept so that it can also be consulted afterwards.



Installation and operation must comply with the local safety regulations in force in the country in which the product is installed.

Everything must be done in a workmanlike manner.

Failure to respect the safety regulations not only causes risk to personal safety and damage to the equipment, but invalidates every right to assistance under guarantee.

INSTALLATION AND SERVICING BY SKILLED PERSONNEL



It is advisable that installation be carried out by competent, skilled personnel in possession of the technical qualifications required by the specific legislation in force.

The term skilled personnel means persons whose training, experience and instruction, as well as their knowledge of the respective standards and requirements for accident prevention and working conditions, have been approved by the person in charge of plant safety, authorizing them to perform all the necessary activities, during which they are able to recognize and avoid all dangers. (Definition for technical personnel **IEC 60364**.)



We suggest special maintenance at least once a year by qualified personnel.

USE ONLY BY COMPETENT PERSONS



The appliance may be used by children over 8 years old and by persons with reduced physical, sensory or mental capacities, or who lack experience or knowledge, on condition that they are under supervision or after they have received instructions concerning the safe use of the appliance and the understanding of the dangers involved. Children must not play with the appliance. Cleaning and maintenance intended to be carried out by the user must not be performed by children without supervision.

MECHANICAL SAFETY



NEVER LET THE PUMP RUN WITHOUT WATER.

Water also performs the functions of lubricating, cooling and protecting the seals: **dry running can cause permanent damage to the pump and will void the guarantee.**

Always fill the filter before starting the pump.

ENGLISH

- Protect the pump from unfavourable weather conditions.
- For long periods of inactivity or frost, remove all the caps and completely drain the pump body. Keep the caps!
- To use as an outdoor pump, provide suitable protection and install the pump on an insulating base at least 100 mm high.
- Store the pumps in a dry covered area, with constant air humidity.
- Do not wrap the motor in plastic bags! Risk of condensation!
- If testing the seal of the pipes at a pressure higher than 2.5 bar, exclude the pump (close the gate valves before and after the pump).
- ATTENTION: do not lubricate the O-ring gasket of the transparent cover with oil or grease.
- Use only water and neutral soap to clean the transparent cover, do not use solvents.
- Periodically inspect and clean the pump filter.
- With the pump under the water level, close the gate valves on suction and delivery before removing the filter cover.



The pumps may contain small quantities of residual water from testing. We advise flushing them briefly with clean water before their final installation.

ELECTRICAL SAFETY



Use is allowed only if the electric system is in possession of safety precautions in accordance with the regulations in force in the country where the product is installed (for Italy CEI 64/2).



All repair and maintenance work must be carried out only after having disconnected the pump from the power supply mains.

RISKS LINKED TO HEATING



When the machine is operating, touch only the parts for settings and controls (operator keyboard): the other parts can reach temperatures higher than 40°C.
Keep inflammable materials far away from the machine.
Run the machine in ventilated environments.

TYPES OF PUMPED LIQUIDS ALLOWED



The machine has been designed and made for pumping fresh or salt water from swimming pools, clean or slightly dirty, with a limited content of fibres and small suspended solid particles.
The water temperature must not be higher than 40°C / 105°F.

DO NOT USE THE PUMP WITH LIQUIDS WITH DIFFERENT CHARACTERISTICS!

Use of the pump with a concentrated amount of sand can cause early wear and decreased pump performance.



Do not add swimming pool chemicals (such as disinfectants, water treatment substances, etc.) directly to the pump or in front of the pump inlet: undiluted chemicals are aggressive and can damage the pump, while also voiding the guarantee.

SPECIFIC RISKS FOR SWIMMING POOLS, BATHING POOLS AND SIMILAR

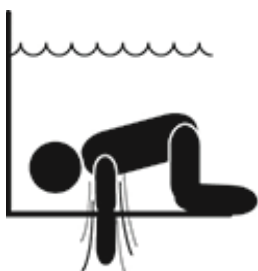

Special warnings for the United States of America (U.S.A.):

SAFETY WARNINGS:

Suction entrapment hazard. Can cause serious injury or death.

To reduce the risk of entrapment the pump must be installed in accordance with the latest federal, state and local swimming pool codes and must be connected to a minimum of two functioning suction outlets per pump or otherwise installed in accordance with the latest APSP-7 standard.

Do not operate pump if any suction outlet cover is damaged, broken, missing or not securely attached.

The use of an approved ASME A 112.19.17 safety vacuum release system (SVRS) is recommended and may be required under federal (U.S.), state or local law.

This pool motor is NOT equipped with a Safety Vacuum Release System (SVRS).

SVRS helps prevent drowning due to body entrapment on underwater drains.

In some pool configurations, if a person's body covers the drain, the person can be trapped by suction.

Depending on your pool configuration, a SVRS may be required to meet local, state, and federal requirements.

For information regarding SVRS requirements and the Virginia Graeme Baker Pool and Spa Safety Act visit www.cpsc.gov



Entrapment hazard

In swimming pools, bathing pools and similar facilities, the water recycling drains cause strong suction when the pump is activated. In this situation there is a serious risk: if a person (especially a child) covers the drain with his body, he could be trapped and held under water until he drowns.

There could be the same tragic outcome if long hair were caught in the drain, trapping the bather's head under water. Also necklaces, parts of swimming costumes or clothing and other objects used in the pool (for example a small life-belt) can be sucked into the drain, blocking the body of the wearer under water, with extreme consequences.

Evisceration hazard (by suction)

The circumstance of strong suction can cause the partial entrapment of limbs and organs, with extremely serious and sometimes fatal consequences.



This is a real risk: in the USA there were 74 documented cases of entrapment and evisceration between 1990 and 2004 (Source: CPSC, USA 2005).

It is therefore obligatory and indispensable to respect all the applicable national and local regulations.



Particular care must be taken in checking periodically that the grids on the suction openings are intact and clean.

Over time, the grids become deteriorated due to age, contact with water and exposure to the sun and to atmospheric agents: they must be checked regularly and with the greatest care, immediately evacuating people from the area if damage is found.



Dangerous pressures

During any operation on the system, air can get in and be pressurized. Compressed air can cause the sudden opening of the cover and cause damage, injuries and even death.

DO NOT RELEASE OR WORK ON THE COVER WHEN THE PUMP IS UNDER PRESSURE.



Use only for fixed facilities of swimming pools and bathing pools. Do not use for seasonal facilities that can be dismantled (that is, where the water retaining walls are deflated or disassembled in winter).

RESPONSIBILITY

The Manufacturer does not vouch for correct operation of the electropumps or answer for any damage that they may cause if they have been tampered with, modified and/or run outside the recommended work range or in contrast with other indications given in this manual.

The Manufacturer declines all responsibility for possible errors in this instructions manual, if due to misprints or errors in copying. The Manufacturer reserves the right to make any modifications to products that it may consider necessary or useful, without affecting their essential characteristics

1 GENERAL

1.1 Description

The system consists of a centrifugal pump and an electronic inverter with advanced control software. It offers a powerful and flexible system for the automation of the water flow for swimming pools, spas, bathing pools and other applications.

The pump is particularly efficient. The presence of the inverter allows considerable energy saving, and therefore economic advantages and protection for the environment; it also allows the complete automation and programmability of switching on, which can be configured easily and rapidly by means of the wide built-in screen and convenient keyboard.

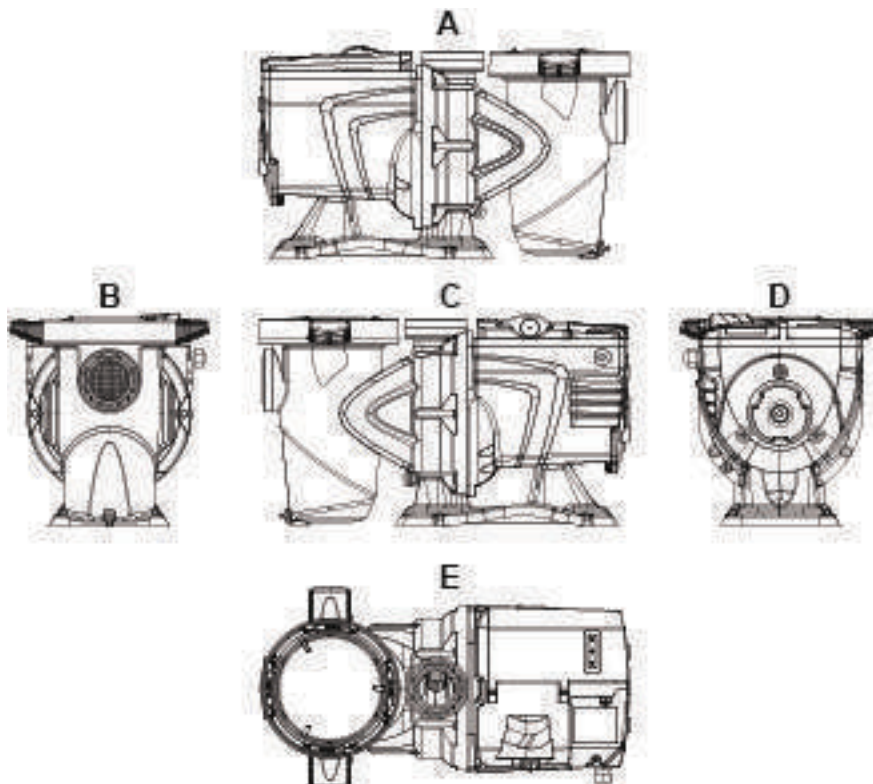

Figure1

ENGLISH

- 1- User panel cover
- 2- User panel
- 3- QR code
- 4- Quick guide
- 5- Terminal board cover
- 6- External connector
- 7- Power cable inlet

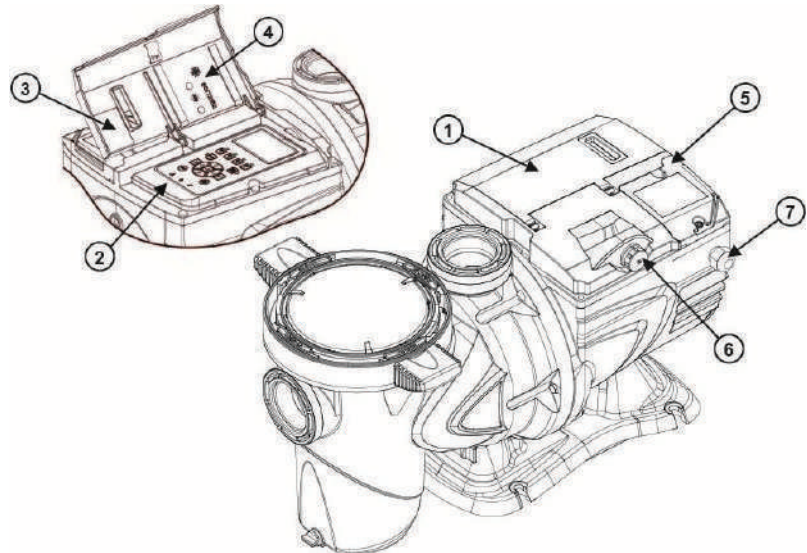

Figure 2

1.2 Technical characteristics

The technical characteristics are summed up in the table below.

Topic	Parameter	E-SWIM
ELECTRIC POWER SUPPLY	Voltage	220-240 V +/- 10%
	Frequency	50/60 Hz
	Maximum current	5.6 SFA
	Maximum power	1250 W
CONSTRUCTION CHARACTERISTICS	Overall dimensions	574 x 310 x 316 mm / 22.6 x 12.2 x 12.4 in
	Empty weight (excluding packaging)	18 kg / 39 lb
	Protection class	IP55
	Motor insulation class	F
HYDRAULIC PERFORMANCE	Maximum head	16 m / 52 ft
	Maximum flow rate	32 m ³ /h / 141 gpm
	Maximum working pressure	2,5 bar
WORKING CONDITIONS	Max liquid temperature	40°C / 104°F
	Max ambient temperature	50°C / 122°F

Table 1 – Technical Characteristics

2 INSTALLATION



The system must be used preferably in the technical area for installing swimming pool pumps. In no case must it be run if exposed without protection to atmospheric agents. The place of installation must be well ventilated.

2.1 Hydraulic connections

Follow these recommendations with care:



- Install the pump horizontally, on a flat and sturdy base, as close as possible to the edge of the pool.
- The pump is able to overcome a maximum difference in level of 4 m (with non-return valve).
- Install the filter and the pump in a protected, well ventilated place.
- Avoid letting the motor be immersed in water.
For pump-system connections use only adhesives suitable for plastics.

ENGLISH

- Provide adequate support for the suction and delivery pipes so that they do not weigh down on the pump.
- Do not make the couplings between the pipes too tight.
- Suction pipe diameter $> =$ pump inlet diameter.
- If a metal pipe is connected, fit a plastic coupling on the pump inlet.
- The suction pipe must be perfectly airtight.
- ATTENTION: before connecting the pipes, check that their inside is clean.
- To avoid problems in suction, install a foot valve and make a positive slope of the suction pipe towards the pump.

2.2 Electrical connection to the supply line

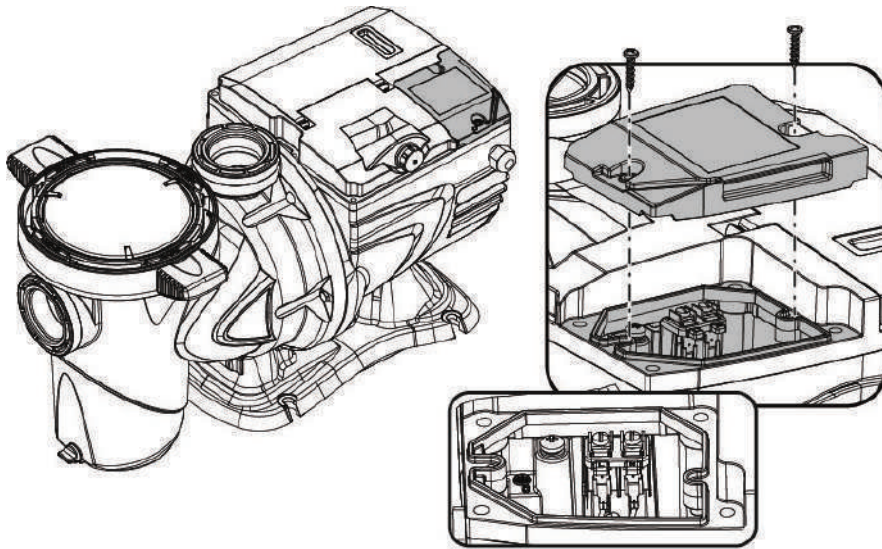

Figure 3

To improve immunity to the possible noise radiated towards other appliances it is recommended to use a separate electrical duct to supply the product.



Attention: always respect the safety regulations!
Electrical installation must be carried out by an expert, authorised electrician, who takes on all responsibility.



The system must be correctly and safely earthed as required by the regulations in force.



The mains voltage must be the same as that on the motor data plate.
Connect to the mains with a two-pole switch, with contact opening distance of at least 3 mm.
The thermal magnetic circuit breaker and the power cables must be correctly sized.
The leakage current to earth is max. 3.5 mA. It is recommended to use a type B differential switch. The system must be adequately sized. The pump must be fed by means of an isolation transformer or a differential switch, which must have a differential operating current no higher than 30 mA.



The mains terminals may still have dangerous voltage when the motor is stopped and for a few minutes after disconnecting from the power mains.



The line voltage may change when the electropump is started. The line voltage may undergo variations depending on other devices connected to it and on the quality of the line.

2.3 Electrical connections for auxiliary inputs and outputs

The pump has a connector for configurable user inputs and outputs.

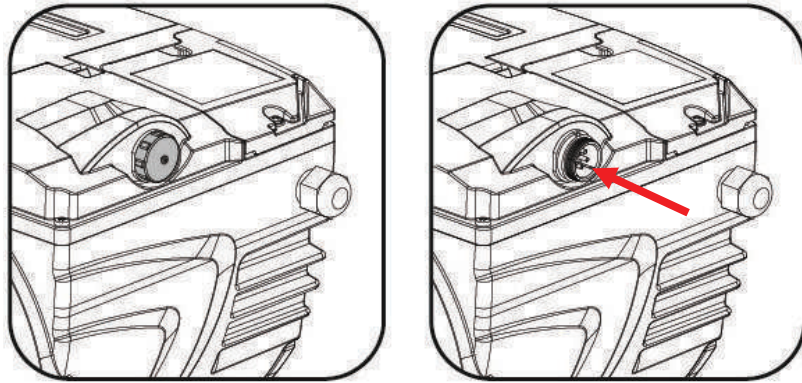

Figure 4

The output is made from a relay (clean contact), with the following electrical characteristics.

Characteristics of the output contacts	
Type of contact	NO (normally open)
Max. bearable voltage [V]	24Vac / 24Vdc
Max. bearable current [A]	2A -> resistive load 1 A -> inductive load
Max. bearable power	2.5VA / 2W

Table 2 - Output contact

The functions that can be activated on the output contact are described in paragraph 6.2.6.2.

The following inputs are available (see also par. 6.2.6.1):

1. A digital input, with clean contact (maximum voltage 5Vdc, maximum current 1mA); the closed contact means "run", the open contact means "stop".
2. An input for an external analog signal, configurable as 0-10V or 4-20 mA .

The following figure shows the relationship between the analog signal on input and the setpoint *SP* to be activated. See the following parts of this manual for further information on operation.

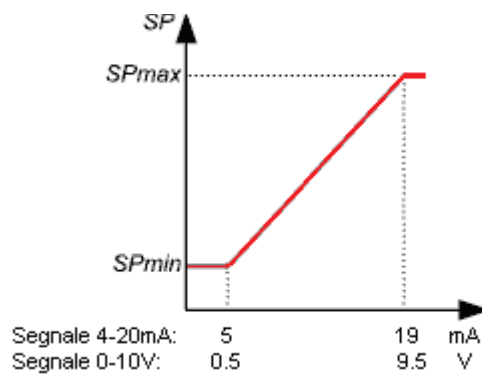

Figure 5



The inputs are not opto-isolated.



To connect to the input and output connector, use only the cable kit with code **DAB 60172444**. The details of the connector and of the connection are included in the kit.



Attention: keep the cable for the input and output signals well away from the power and alternate supply lines (230V and similar), so as to limit disturbances and interference that can alter the signals.



When it is not in use, the connector on the pump must be kept accurately closed, with the cap well tightened. Only in this way is the necessary resistance to water and damp guaranteed.

3 THE OPERATOR PANEL

3.1 Keyboard and Display

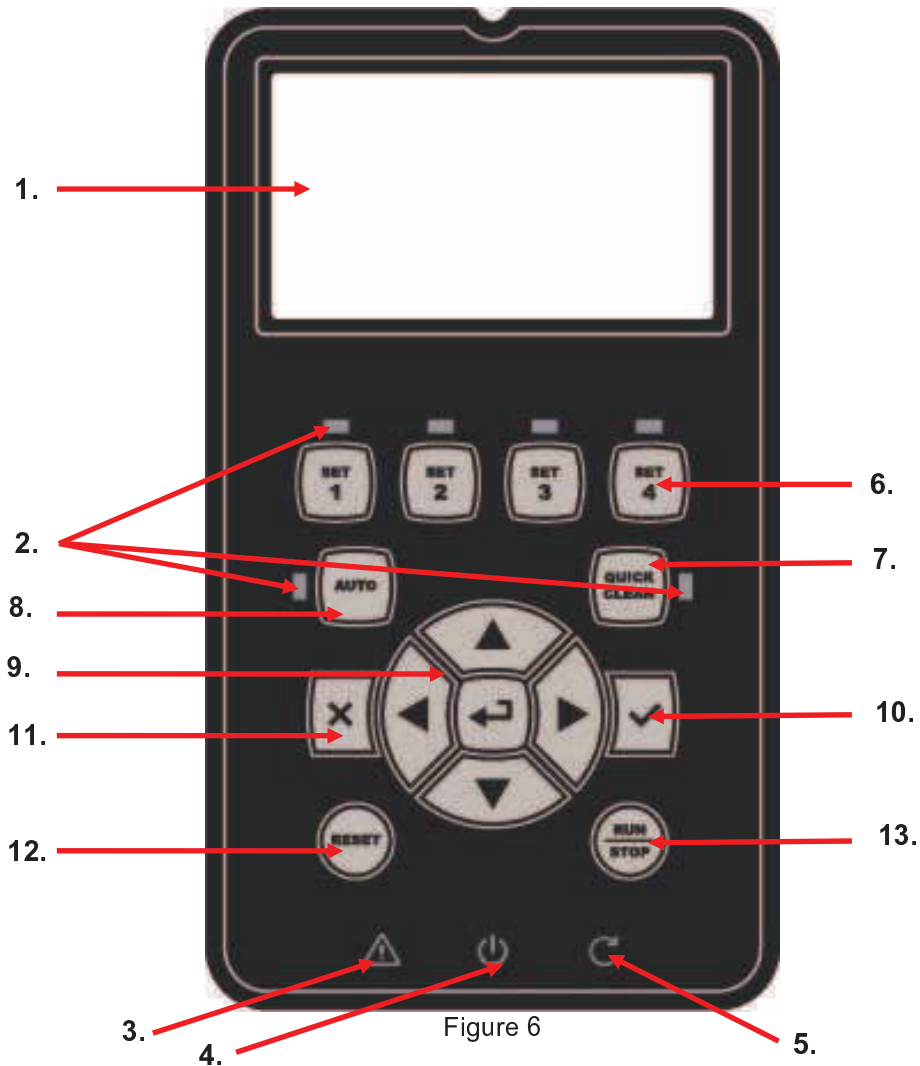

Description of the elements:

1. LCD graphic screen
2. (Six) LED warning light indicating the active function; each LED indicates the activation of the key next to it.
3. LED red warning light (Δ), for alarm indication (fault).
4. LED white warning light (Φ), lit to indicate that the board is live; if it is blinking, it means that the board is live, but the pump is not enabled (see "RUN/STOP" key below).
5. LED green warning light (C), indicates that the pump is running.
6. (Four) keys "SET 1-4" for manual control of switching on, for directly selecting (or deselecting) a set flow or speed (setpoint).



The table in chapter 8 shows the factory values of the setpoints associated with the keys from “SET1” to “SET4”. These values are suitable for most installations, but they can be easily changed if desired (see 6.2.2).

7. Key for activating “QuickClean” mode, to command quick cleaning or quick recirculating with a high flow rate.
8. Key for enabling “Auto”, mode, for activating the automatic control of the pump (which may be timed (“Timers”) or given by external signals (“EXT”).
9. Keys for navigating and accessing the menus:
 - the “ENTER” key allows you to access the menus and the items on which you are positioned;
 - the “arrow” keys allows you to move about on the display or in the active menu, and to select an item; they also allow you to change the value of the selected item.
10. “OK” key, to confirm and to leave without saving the changes made.
11. “ESC” key, to cancel any changes and leave (without saving).
12. “Reset” key, to cancel the alarms (*faults*) that may be in progress.
13. “RUN/STOP” key, to enable or disable running of the pump; the pump enabled status is indicated by the steady lighting of the white LED Φ , which blinks if running of the pump is disabled.



When the pump is running (green LED Φ lit), the pump stops if “RUN/STOP” is pressed, whatever the operating condition, in both “Manual” and “Auto” mode.

However the “RUN/STOP” control is not direct starting control, but only an enabling: if it is pressed with the pump stopped (green LED Φ off), the pump starts only if a mode is active that contemplates switching on at the current moment.

In STOP condition, when the white LED is blinking, the pump can never stop until “RUN/STOP” is pressed.



The only exceptions:

- the “Antifreeze” function can start the pump even in STOP status, to avoid breakages due to frost (see paragraph 6.2.8);

- the “Antilock” function can start the pump even in STOP status, to avoid mechanical blocking of the impeller after long inactivity (paragraph 6.2.9).

The keyboard can be blocked with a (“Password”); in this way access to the functions can be restricted, to avoid undesired intervention. See paragraph 6.2.1.7.

3.2 Main page of the display (*homepage*)

This is the appearance of the home page, which appears on the display in normal operating conditions and sums up all the information on system operation.

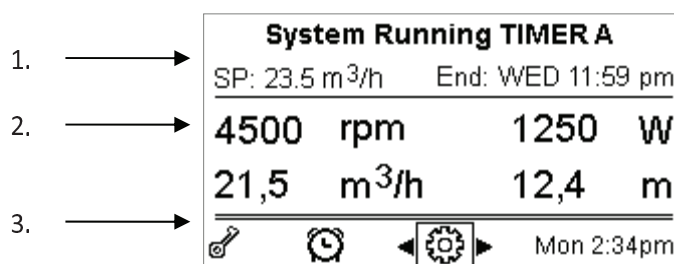







Figure 7

The information forms three groups:

1. The status lines (at the top) provide information on:
 - the status (running, stopped) along with the current command (SET1 – SET3, QC, Timer A-H, etc.), or any active Warnings and Faults; in the example in the figure: “System Running” indicates that the system is active, commanded by “TIMER A”.
 - the active setpoint value (“SP”) and the expected time of the end of the active function (“End”).
2. The instantaneous values of the electrical and hydraulic magnitudes, which are grouped in the space in the centre of the screen and continuously updated during operation.
3. The rapid access bar (at the bottom): contains the date and time with some icons; you navigate on these elements with the *right arrow* and *left arrow* keys, and move the selection (highlighted by the box), then press “ENTER” [Enter] to go to the selected item.

ENGLISH

This gives simple and direct access to the items used most frequently, without having to scroll through the menu. These are the items available and the functions accessed:

- "Configuration"  → Menu access (see chapter 6),
- Current "Date and time" → direct change of date and time (paragraph 6.2.1.3),
- "Timer"  → access to the *Timers* (paragraph 6.2.5),
- "Key"  (or padlock) → direct access to the protection system with Password, described in paragraph 6.2.1.7; the symbol represents the current status:
 -  (key) Password not entered, free access to all functions;
 -  (closed padlock) Password entered and active, access to the control keys is prevented (except the "STOP" key);
 -  (open padlock) Password entered but temporarily deactivated, access is temporarily allowed.

4 COMMISSIONING

4.1 Priming

Installation below water level:

Fit one gate valve in the suction pipe and one in the delivery pipe to isolate the pump.

Fill the pump, slowly and completely opening the gate valve in the suction pipe, and keeping the gate valve on delivery open to let the air out.

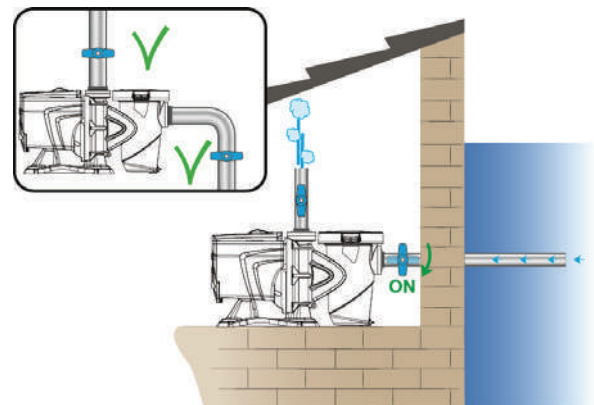

Installation above water level:

If there are several suction pipes, arrange the pipes and the manifold below water level and reach the pump with only one vertical pipe.

To reduce the priming time, it is recommended to install the pump with as short a suction pipe as possible.

Fill the basket of the filter with water up to the level of the suction mouth.

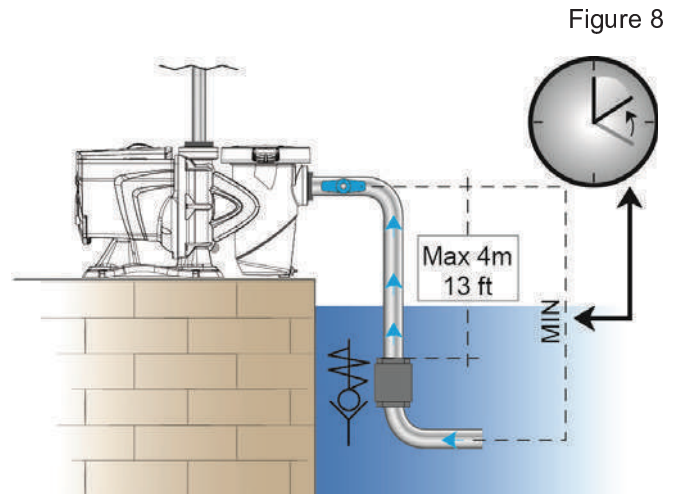

Figure 8

4.2 Guided configuration (WIZARD)

When switched on for the first time, the device proposes to perform the WIZARD easy configuration, which guides the user in a fast and easy setting of the most important parameters.



It is necessary to perform the WIZARD: the initial system status is that of the factory configuration, and in that the language and the units of measure may not be those used in your country, the weekly clock starts at a random time, and the other parameters may not be suitable for your system.



If you need to revise all these parameters quickly at a later date, you can reload the WIZARD by selecting a specific item on the menu (paragraphs 6.2 and 6.2.1.1).

The WIZARD presents the following pages in sequence:

1. Select Language (see also par. 6.2.1.2)
2. Select time display mode (24h or am/pm)

3. Set current time
4. Set current day
5. Set Unit of measure of head
6. Set Unit of measure of flow
7. Set Unit of measure of temperature
8. Selecting Regulating Mode
9. Select maximum limit of flow (Qmax) (see also par. 6.2.1.5)
10. Select maximum limit of head (Hmax)
11. Final confirmation

Each page of the Wizard presents a single parameter to configure, starting from the language.



Figure 10

As well as the title, the page shows these indications:

- symbol “1/11”: indicates the current page number (1), out of the total pages of the WIZARD (11), and of course it changes from one page to the next;
- in the centre of the page is the list (or menu) of the various languages available, and the box shows the language currently selected;
- the vertical bar, represented on the left, shows the position where we are on the list (or menu) of the languages available; in the example, we are in the first position and the sign on the bar is at the top;
- the keys to use are indicated at the bottom (as well as the arrows which, for simplicity, are not shown):
 - “OK” key [OK ➤]: confirms any changes made and allows you to proceed to the next page;
 - “ESC” key [⏏ ESC]: cancels any changes made; when you press it again, or if no changes have been made, it returns to the previous page.

As is intuitive, use the *up arrow* and *down arrow* keys to scroll through the list of languages to select the one you want, then press “OK” [OK ➤]. The selected language is activated and you proceed to the next page (number 2/11) of the WIZARD.

On some pages, such as the one with hours and minutes, the arrows also allow you to change the value displayed. After having chosen the units of measure and, if necessary, set the limits of the flow rate and head, a page is shown telling you that the Wizard is complete. By pressing “ESC” you can go back to review or change the settings; by pressing “OK” you leave the Wizard and proceed to normal pump operation.

5 SWITCHING ON AND USING THE PUMP

5.1 Operating mode

5.1.1 Regulating modes

The following diagram shows the indicative curves of the system’s hydraulic performances.

Head H
ft m

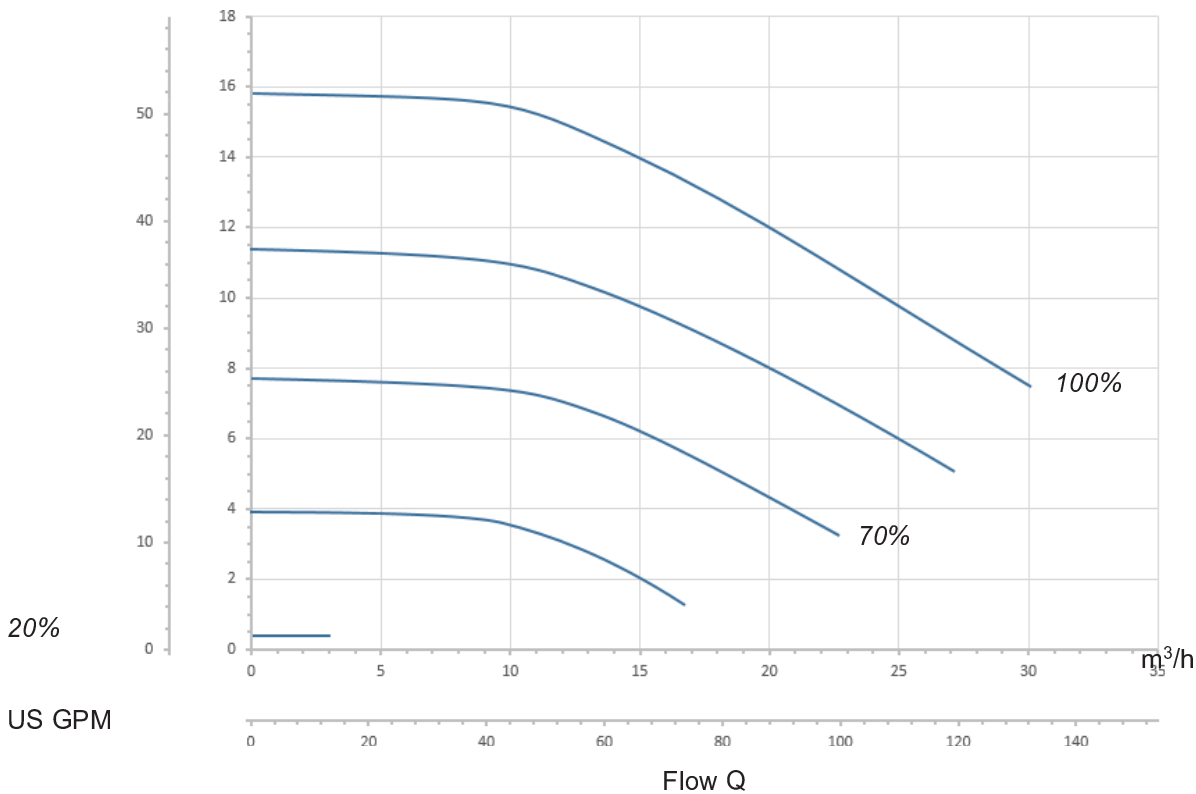

Figure 11

The inverter automatically regulates the rotation speed of the pump, shifting the work point, as necessary, to any part of the area subtended by the maximum curve (100%).

Regulation during pumping can take place in *flow control* mode or in *fixed curve* mode.

- In *“flow control”* (*“Flow”*) the system assesses the instantaneous flow of water and varies the pump speed so that the flow corresponds to the setpoint, expressed in this case in *“m³/h”* (cubic metres per hour) or *“GPM”* (US gallons per minute). In this mode, the work point moves (ideally) on a vertical line, corresponding to the flow value chosen.
- In *“fixed curve”* mode (*“Speed %”*), the setpoint (expressed as a percentage *“%”*) indicates the operating curve on which you want to be positioned. As can be seen in the figure, the operating point then moves following the trend of the curve chosen, which is similar to the trend of fixed speed curves in traditional pumps.

Generally, when the work point falls below the maximum curve, the system reduces the absorbed power and thus decreases the energy consumption.

5.1.2 Command modes

The system can operate in two control modes: *“Manual”* mode and *“Auto”* mode.

In *“Manual”* mode:

- the operator manually commands the switching on of the pump by pressing the keys from *“SET1”* to *“SET4”* or *“QuickClean”*;
- the LED next to the key that has been pressed lights up (for example, if *“SET1”* is pressed the LED above this key is lit).

In *“Auto”* mode:

- switching on and off are automatically commanded by Timers, which can be programmed as desired on a weekly basis, or by signals arriving from an external control unit (*“EXT”*).
- This mode is disabled when the system leaves the factory.

To activate it, you must first of all configure the necessary parameters (see 6.2.5 and 6.2.6), and then press the *“Auto”* key (the respective LED lights up).



“Manual” mode and *“Auto”* mode can also be used simultaneously; in this case, as will be described better below, the automatism (*“Auto”*) remains active in the background but, if necessary, it can be temporarily overridden by a manual command, which has precedence.



5.2 Rapid starting and stopping of the pump ("Manual" mode).



*The pump leaves the factory and is delivered with Priming enabled: if the programming of Priming is not changed (see par. 6.2.7), **when switched on for the first time, the pump may start at top speed.** Before pressing "RUN/STOP", make sure that the valves are open, the pipes are not blocked, and keep away from the filter and from parts that can be pressurized.*
Check well all the IMPORTANT SAFETY WARNINGS AND RECOMMENDATIONS.

Once the first configuration has been carried out with the WIZARD (in conditions with the white LED  blinking and the "Auto" LED off), starting the pump is very easy:

- press the key from "SET1" to "SET4" corresponding to the desired setpoint (e.g. "SET1"), or the "QuickClean" key; the LED corresponding to the key pressed lights up, indicating the selection made;
- press "RUN/STOP".

At this point, switching on is enabled and the pump starts; the green running LED  lights up, while the white LED  is lit with a steady light (indicating that now the system is active).

The system performs *startup*: the pump starts at a fixed speed (50%) for a few seconds.



Startup is necessary for the pump to switch on correctly, and it is always performed at each start of the motor.

Priming is then performed (par. 6.2.7), if it is enabled (according to factory setting).

After that, the pump continues to run according to the setpoint associated with the "SETx" or "QuickClean" function used (in the example, the "SET1" setpoint).



The factory values are given in chapter 8.

*For the "SETx" keys, it is easy to change the setpoint (choosing also between flow or speed) and the other characteristics (duration) by means of the menu (see 6.2.2).
 Also the operation associated with the "QuickClean" key can be customized (see 6.2.4).*



Pressing a "SETx" or "QuickClean" key puts the pump into "Manual" mode, which has precedence over "Auto" mode: even with "Auto" active ("Auto" LED on), pressing a "SETx" or "QuickClean" key will start the pump with the setpoint associated with the key.

An execution time or duration is also associated with each "SETx" function and with "QuickClean".

The following events may occur while the pump is running:

- the end of the time (or duration) associated with the "SETx" or "QuickClean" key selected previously is reached,
- or the same "SETx" or "QuickClean" key is pressed again;



in both cases, the key function ceases, its LED switches off, and the pump stops.



However, if the "Auto" function was active in the background ("Auto" LED lit), it now takes control of the machine, deciding either to switch off the pump or to switch on with another setpoint, depending on the programming made. So the pump might not switch off.

It is very easy to stop the pump manually: with the pump running, just:

- press "RUN/STOP".

the pump thus stops in any case (*), interrupting all active modes (this means that also "Auto" mode, which may have been active in the background, switches off); the green running LED  switches off. The white LED  starts to blink, indicating that the system has been disabled.

When "RUN/STOP" is pressed again, the system is re-enabled and everything is restarted; the white LED  is now lit with a steady light.

(* The only exceptions: the *Antifreeze* and *Antilock* functions start the pump even if the system is disabled (see paragraphs 6.2.8 and 6.2.9).



After a blackout during operation in Manual mode, the system does not restart unless the SETx key that was lit had the duration "ENDLESS". In this case, the system restarts with the same setpoint as before.

5.3 Rapid changing of the setpoint and of the pre-set parameters

When the pump is running with a “SETx” key pressed (as described above):

- pressing a “SETx” key different from the active one (e.g. “SET3”, while “SET1”, is active) will perform the setpoint of the new key (for the whole respective duration) and the lighting of the LEDs changes accordingly;
- instead, by pressing the *up arrow* and *down arrow* keys, you can increase or decrease the flow or speed (setpoint) at which the pump is operating. The setpoint value is shown on the display on the *homepage* (see par. 3.2).

The modified value is stored automatically in the same “SETx” key currently selected (the one with the LED lit).

Also if “QuickClean” has been pressed and the pump is running, the setpoint can be changed with the arrow keys as described above; the new value is saved directly in the “QuickClean” key.



Both a setpoint and an execution time (or duration) are associated with each “SETx” and “QuickClean” key. Unlike the setpoints, the times cannot be changed with the quick method described above; however, they can be changed easily (see 6.2.2 and 6.2.4). The factory values are given in chapter 8.

5.4 Advanced use (“Auto” mode)

On this machine there is a powerful and sophisticated system of timed starting at different setpoints, each with a different duration, which can be planned as preferred on a weekly basis. A simple setting of the parameters is sufficient to perform all the desired cycles completely automatically for seven days. This mode is called “Timers”. (See par. 6.2.5.)

It is also possible to have all the pump starts commanded by an external control unit or computer, connected to the input signals (described in 2.3.). This mode is called “EXT”, or external (see par. 6.2.6). In this case the internal timers do not intervene.

These two modes make up the “Auto” mode.

It is disabled when the pump leaves the factory, because it must be configured specifically for each system (swimming pool, bathing pool, spa, etc.).

To enable “Auto” mode, just go to the menu (par. 6) and, following the indications on the screen, choose the mode (Timers or Ext) and set the values for your system.

After having programmed “Auto” mode, proceed as follows to activate it (in conditions with the white LED  blinking and the “Auto” LED off):

- with the pump stopped, press the “Auto” key (the LED next to the key lights up),
- then press “RUN/STOP” (the white LED  lights up with a steady light).

From this moment, the pump starting operations, with their respective setpoints and operating times, will be decided automatically, without requiring any further intervention by the operator.



Even with “Auto” mode active (“Auto” LED on), pressing a “SETx” or “QuickClean” key will start the pump immediately with the setpoint and the duration associated with the key. The pump thus goes into “Manual” mode, which has precedence over “Auto” mode.

However, “Auto” mode remains active in the background and resumes control as soon as the function of the key that was pressed ceases.



To deactivate “Auto” mode:

- press the “Auto” key again (the LED next to the key lights up).

If you need to stop the pump manually when it is operating, just:

- press “RUN/STOP”.

the pump thus stops in any case (*), interrupting all the active modes.

This means that “Auto” mode stops and also any active manual mode (“SETx” or “QuickClean”); the green running LED  switches off. The white LED  starts to blink, indicating that the system has been disabled.

When “RUN/STOP” is pressed again, the system is re-enabled and everything restarts as before. The white LED  is now lit with a steady light.

(*) The only exceptions: the *Antifreeze* and *Antilock* functions start the pump even if the system is disabled (see paragraphs 6.2.8 and 6.2.9).

6 SELECTING THE PREFERRED MODES (MENU)

A rapid and intuitive menu system gives access to the various modes, allowing you to activate and configure them as desired.

6.1 Menu access and navigation

The menu is accessed by pressing the “ENTER” key [↵Enter] when the item “Configuration”  is selected in the bar at the bottom of the homepage (par. 3.2).

The complete structure of the menu, with all the items of which it is composed, is shown in paragraph 6.2.

6.1.1 Appearance and opening page of the menu

When you enter the menu, the opening page appears, as in the figure:

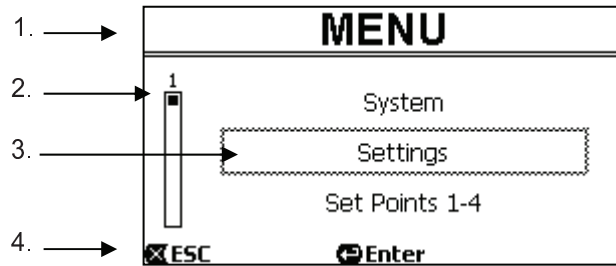

Figure 12

The page contains these elements:

1. The line at the top shows the page title, in this case “Menu”.
2. The bar on the left indicates in what position we are with respect to the extension of the menu; in this case we are at the start and the internal sign is at the top end.
3. The centre of the page contains a part of the list of items that make up the menu, which we can scroll through with the arrow keys (*up* and *down*); the item on which we are positioned is highlighted by the flashing box (dotted in the figure). The previous menu item (at the top) and the next item (at the bottom) are also shown.
4. The line at the bottom indicates which keys can be used on the page, as well as the arrows (not shown for simplicity). In this case we can press “ESC” [⌫ESC] to leave, or “ENTER” [↵Enter] to access the selected item.

The following figure shows how the display changes when the *down arrow* key is pressed.

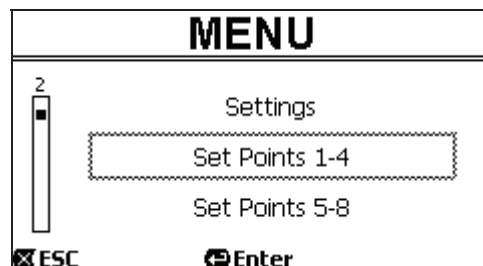

Figure 13

Now the flashing box (dotted here) highlights the item after the one in the previous situation; in the vertical bar on the left, the internal sign is lower down, showing that we are positioned farther down the items that make up the menu. When we press the up arrow key, we return to the situation in the previous figure.

The list of items in the menu should be considered as cyclical, that is as a loop: from the last item it returns to the first with the *down arrow* key. And from the first item it goes to the last with the *up arrow* key.

The complete structure of the menu is shown in paragraph 6.2.

6.1.2 Access to a sub-menu

When some items on the menu are accessed, a further menu, or sub-menu, may open. This happens, for example, on the initial page of the menu, shown above:

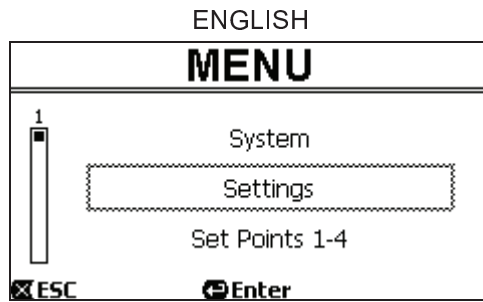

Figure 14

When we press “ENTER” [Enter] to access the “Settings” item, we access the respective “Menu - Settings”:

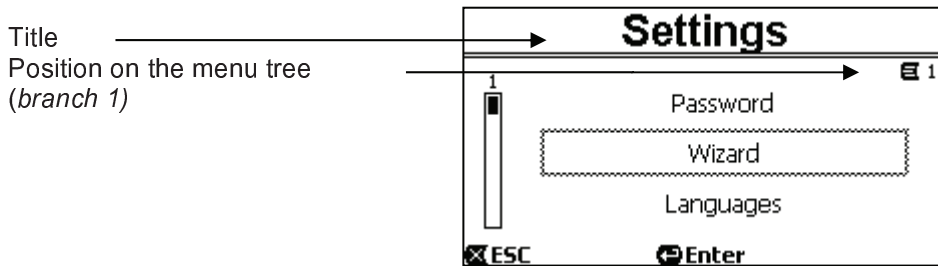

Figure 15

We can also navigate the sub-menus with the arrow keys and access the desired item by pressing “ENTER” [Enter]. The symbol at top right represents the position on the menu tree; here we are in branch number 1. As well as the complete menu structure, paragraph 6.2 also shows the branch (and item) numbering of all the parts of the menu.

6.1.3 Changing a parameter in the menu

Let us see how to change the value of a parameter, for example the time setting. Suppose we want to set 12:34 as the current time.

1. Navigating in the menu (see table in par. 6.2), we arrive at this page:

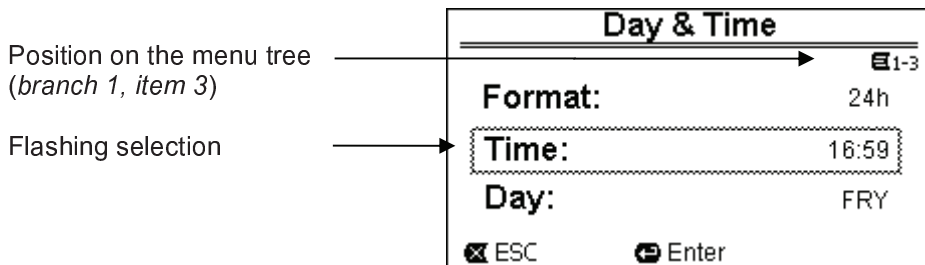

Figure 16

2. Pressing “ENTER” [Enter] opens the modification of the selected line:

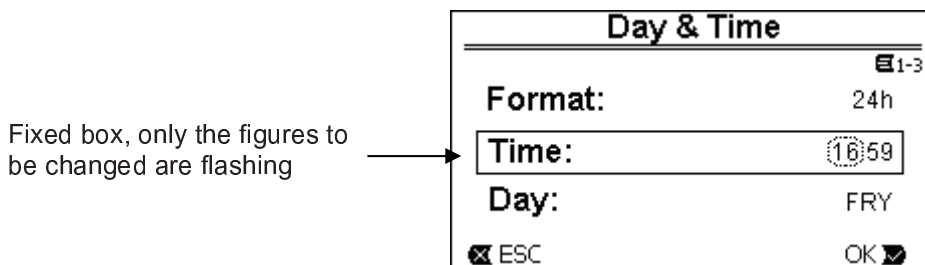

Figure 17

ENGLISH

3. The figures for the hours are flashing and are changed as desired with the *up arrow* and *down arrow* keys:

The screenshot shows a menu titled "Day & Time" with a page indicator "1-3" in the top right. The menu items are: "Format:" with value "24h", "Time:" with value "12:59" (the "12" is flashing), and "Day:" with value "FRY". At the bottom, there are two options: "ESC" with a left arrow and "OK" with a right arrow.

Figure 18

4. When we reach the desired value, we proceed to the minutes with the *right arrow* key:

The screenshot shows the same "Day & Time" menu. The "Time:" field now shows "12:59" with the "59" flashing. The "Format:" and "Day:" fields remain "24h" and "FRY" respectively. The "ESC" and "OK" options are still at the bottom.

Figure 19

5. Now the figures for the minutes are flashing, they too are changed with the *up arrow* and *down arrow* keys:

The screenshot shows the "Day & Time" menu with the "Time:" field set to "12:34" (the "34" is flashing). The "Format:" and "Day:" fields are "24h" and "FRY". The "ESC" and "OK" options are at the bottom.

Figure 20

6. When the new value is completed (12:34 in the example), we confirm by pressing "OK" [OK], and leave the hour and minute setting, as shown in the following figure. (Instead, if we want to abandon the changes made, we press "ESC" [ESC] to return to the figure in point 1).

The screenshot shows the "Day & Time" menu with the "Time:" field set to "12:34". The "Format:" and "Day:" fields are "24h" and "FRY". At the bottom, there are two options: "ESC" with a left arrow and "Enter" with a right arrow.

Figure 21

If necessary, we can now move about the page (with the *up and down arrow* keys) to change the other values (format and day of the week), proceeding in the same way as described so far.

Pressing "ESC" [ESC] takes us back in the (sub-) menu structure, and navigation can be continued in each of these. Pressing "ESC" [ESC] several times takes us right out of the menu, until we return to the main page (par. 3.2).

6.2 Menu structure

This is the complete (tree) structure of the menu.

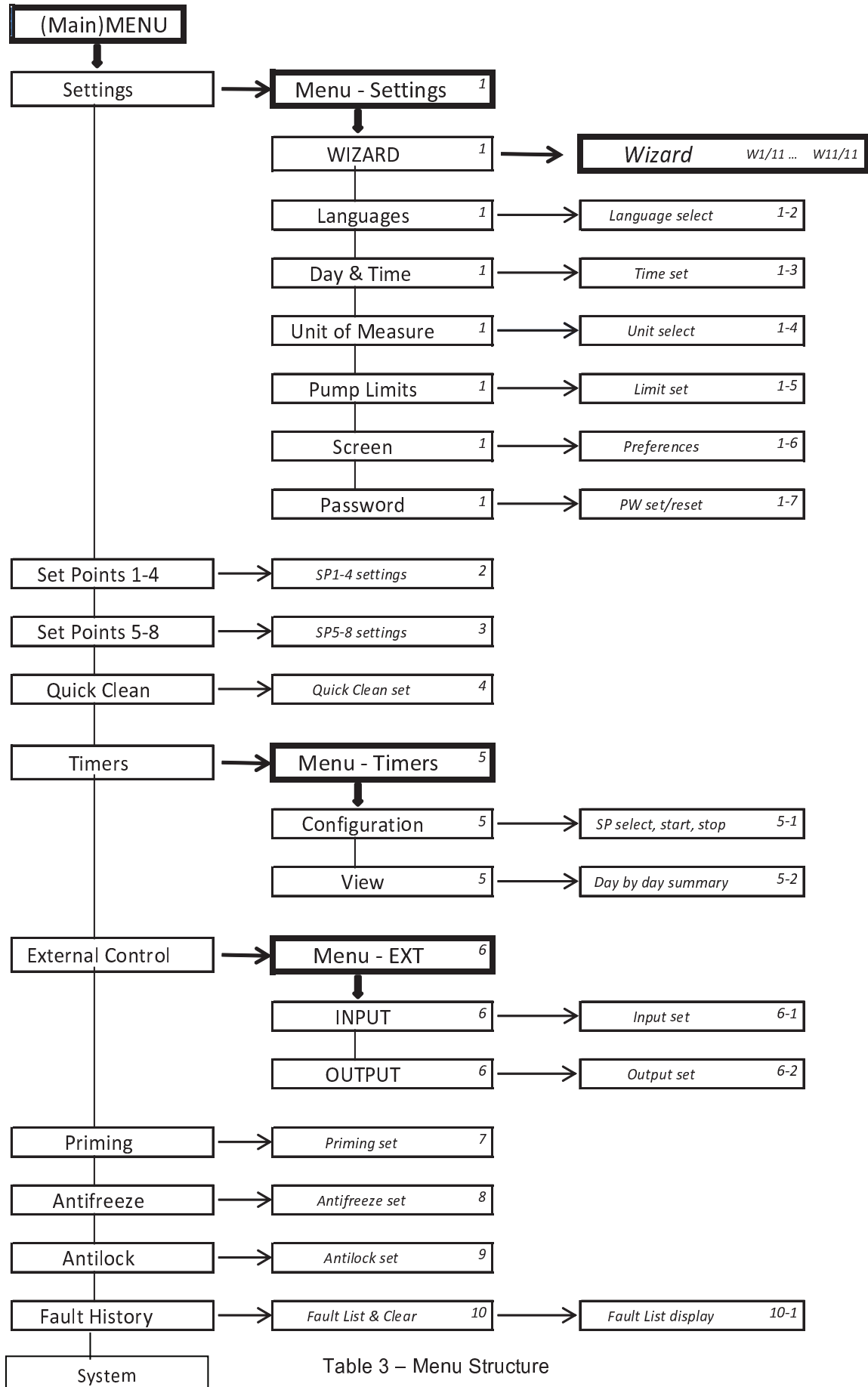

Table 3 – Menu Structure

The numbers, shown on the right in the various boxes, represent the branch and item numbering of the different parts of the menu and are shown on the display (providing a quick reference for the position where we are).

The following paragraphs describe each menu item in detail.

6.2.1 Settings

The “Settings” sub-menu allows us to reactivate the WIZARD (as at the first installation) and to access a series of parameters for customising the system.

6.2.1.1 WIZARD (loaded from the menu)

The easy configuration Wizard, proposed automatically at the first switch-on (see par. 4.2), can be loaded manually from this menu item.

6.2.1.2 Languages

Selection of the language we want to use on the displays.



Figure 22

The choice is made by selecting the desired language (with the *up arrow* and *down arrow* keys) and pressing “OK”. The factory setting is given in chapter 8.

6.2.1.3 Day & Time

From this page we set the current day of the week and time, along with the preferred format for the hours (that is 1 – 24, or 1 – 12 with AM or PM).

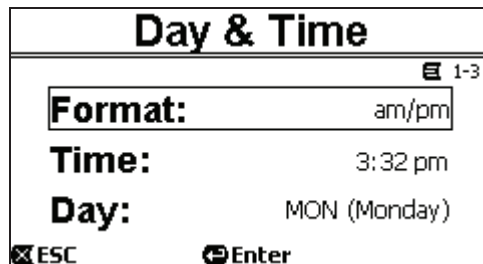

Figure 23

Paragraph 6.1.3 describes in detail how to set the time. Date and time are not determined when the system leaves the factory.

6.2.1.4 Unit of Measure

Selection of the units of measure used by the machine.

The following table shows the units that can be selected; the choice is separate for each quantity.

Units of measure displayed		
Quantity	Metric units	Imperial units
Head H	m (metres)	ft (feet)
Flow Q	m ³ /h	US GPM
Temperature	°C	°F

Table 4 – Units of measure

The units of measure for flow are “*m³/h*” (cubic metres per hour) or “*GPM*” (US gallons per minute). The factory setting is given in chapter 8.

6.2.1.5 Pump Limits

Figure 24

If the system is not able to bear pressures or flows that are too high, it is possible to impose maximum limits on the pump control.

The upper settable limits are:

- Head H_{max} : between 5 m and 16 m, or no limit (*MAX*),
- Flow Q_{max} : between 10 m³/h and 30 m³/h, or no limit (*MAX*).

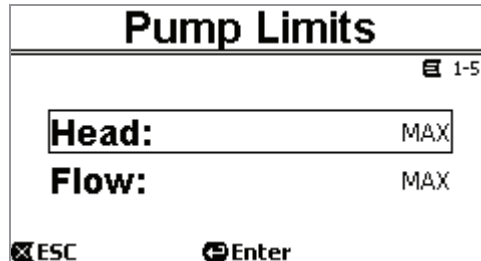
In the factory setting, these limits are not active, and both parameters are set at “MAX” (see also the table in chapter 8).



Note: if the upper limits H_{max} and Q_{max} are set at values lower than “MAX”, it is possible to set the setpoints even at values larger than the limits; however, during activation these upper limits will never be exceeded (self-limitation of the system) and the setpoints may not be reached.

6.2.1.6 Screen adjustment

Figure 25

The LCD screen allows the adjustment of:

- backlight,
- backlight time, counted from the last time a key was pressed.

The backlight time can vary from 20 sec to 10 min, or it may be “always”.

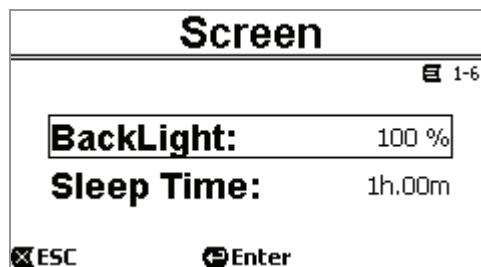
When the backlight is off, the first time any key is pressed has the sole effect of restoring the backlighting.

The factory values are given in chapter 8.

6.2.1.7 Password

The inverter has a protection system with a password, with which it is possible to prevent accidental access, or access by unauthorized persons, to the control keys and the programmed parameters.



Figure 26

The password value can be set from the menu page:

- When the password is “0” (as when leaving the factory), all the keys are unlocked and usable and you can freely access the various menus and modify all the parameters. The “key” symbol appears on the homepage (paragraph 3.2).
- When a value other than zero is set in the password field, and confirmed with “OK”, the value displayed becomes “XXXX” (hidden) and the protection system is activated. The “closed padlock” symbol appears on the homepage (paragraph 3.2).

With the protection active, access to all the keys is blocked, except:

- the **"RUN/STOP"** key: it can be pressed to stop the pump.
NOTE: pressing it again will not restart the pump, because the system will ask for the password;
- the navigation and menu access keys (**"ENTER"** key and **"arrow"** keys): it is possible to navigate in the menu pages and to view the various parameters, but any attempt to change them will require you to enter the password.

When the correct password is entered, the keys are unlocked and the parameters can be changed; the **"open padlock"** symbol appears on the homepage (paragraph 3.2).

When you have finished changing the parameters, the password can be reactivated from the homepage, by selecting the **"open padlock"** icon (paragraph 3.2) and pressing **"ENTER"**.
After eight hours of inactivity (without any keys being pressed), the password will be automatically reactivated anyway.



The password status is always visible, as it is represented with a special page on the homepage; see paragraph 3.2.

The factory value of the password is "0". See also the list of factory values in chapter 8.

If the password is lost, there are two possibilities for editing the parameters of the device:

- Make a note of all the parameter values and reset the device the factory values (see par. 8.1). The reset operation deletes all the device parameters, including the password, and thus re-enables the system.
- Apply to your service centre to receive a code to unlock the device.

6.2.2 Set Points 1-4

The parameters associated with the keys from **"SET1"** to **"SET4"** can be viewed and changed under this menu item, through the page shown on the screen.

Set Points 1-4			
Mode: Flow		E2	
S1	10.0 m ³ /h	T1	Forever
S2	15.0 m ³ /h	T2	24h 00m
S3	20.0 m ³ /h	T3	0h 30m
S4	25.0 m ³ /h	T4	2h 15m
ESC		Enter	

Figure 27

The first choice to make is whether you want the setpoints **"SET1-4"** to set the system regulation mode to **"Flow"** or **"Speed %"** (see paragraph 5.1.1).

To do this, go to the first parameter shown at the top of the page, press **"ENTER"** and make the selection with the **right and left arrow** keys, then press **"OK"** to confirm.

This selection, which is unique for the setpoints 1-4, also modifies the setpoint units of measure, which become respectively:

- in **Flow**: **"m³/h"** with settable values between 5 and 25 m³/h (or **"GPM"**, between 20 and 110 GPM),
- in **Speed**: **"%"** (percent), with settable values between 20% and 100%.

The units of measure and the values assigned to the setpoints (indicated with **S1 - S4**) are clearly shown on the screen.

To change them, move with the arrows onto the value to be changed, press **"ENTER"** and change the value with the vertical arrows; press **"OK"** to confirm the change and move on to the next values.

Each set point has its own duration, indicated on the display with the symbols **T1 - T4** and settable between 10 minutes and 18 hours, or **"ENDLESS"**.

The values **T1 - T4** are changed in the same way as described above.



The duration value indicates the time that the setpoint remains active, after which it ends; if you want the setpoint to remain always active without interruption, the duration must be programmed as **"ENDLESS"**.

The factory values are given in chapter 8.

6.2.3 Set Points 5-8

This menu items allows you to view and change the parameters associated with the setpoints from 5 to 8.

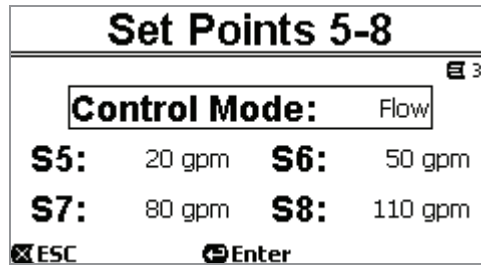

Figure 28

The setpoints from 5 to 8 cannot be loaded from the keyboard, but they are activated and deactivated only by the *TIMERS* system (paragraph 6.2.5). Unlike setpoints 1-4, they do not have any associated duration, as the activation time is decided always and only by the *TIMERS*.

Like the setpoints 1-4, here too you choose the regulation mode by *flow* or *speed* (see paragraph 5.1.1) and the setpoint values, indicated with S5 – S8.

The procedure for selection and changing is identical to the one described in the previous paragraph.

The factory values are given in chapter 8.



To simplify the use of the Timers, it is recommended to assign increasing values to the setpoints, from Setpoint 5 to Setpoint 8 (see par. 6.2.5 and following).

6.2.4 Quick Clean

The “QuickClean” key allows you to perform a rapid wash of the system or fast recirculation, for example by cleaning, suction, adding chemicals, and so on.

Its parameters are:

- setpoint in *Speed %*, settable between 20% and 100%;
- duration (execution time), settable between 1 minute and 10 hours.

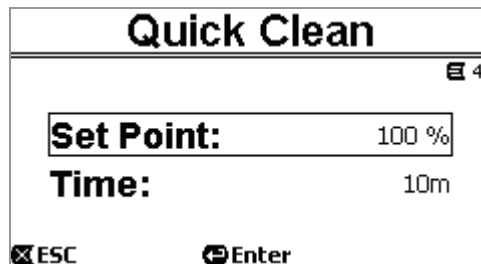

Figure 29

The factory values are: maximum curve 100%, for ten minutes (see also chapter 8).

6.2.5 Timers

There are eight different timers on the machine, from *Timer A* to *Timer H*, each of which allows timed starting and stopping, on a weekly basis, of a setpoint chosen from *Set Points 5-8*.

With a simple setting you can thus automatically carry out all the desired cycles, repeated weekly. To use this mode, see also paragraphs 5.1.2 and 5.4.

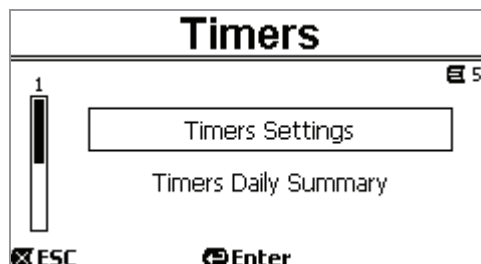

Figure 30

From this sub-menu you can:

- set the timers,
- view the currently active program.

When the system leaves the factory, the timers are disabled and not programmed.

6.2.5.1 *Timer Settings*

Programming of the timers is carried out in “table” form: a table appears on the display, showing the activation data of each of the eight *Timers A – H*.

Timers Settings					
E	Start	Stop	S	Days	5-1
				SMTWTF S	
H	<input type="checkbox"/> 12:00 am	8:10 am	5	<input type="checkbox"/>	<input type="checkbox"/>
A	<input checked="" type="checkbox"/> 5:30 am	7:00 am	6	<input checked="" type="checkbox"/>	<input checked="" type="checkbox"/>
B	<input type="checkbox"/> 11:00 pm	11:01 pm	8	<input checked="" type="checkbox"/>	<input type="checkbox"/>
<input checked="" type="checkbox"/> ESC			<input checked="" type="checkbox"/> Enter		

Figure 31

The following are set for each timer:

- the START time,
 - the STOP time,
 - the desired SET POINT (under the symbol “S”), chosen among the 4 speeds/flows of the *Set Points 5-8*,
 - the days of the week on which the timers are to be activated (the boxes for the days are marked),
- and lastly it is possible to enable or disable the timer, by marking or not marking the box under the symbol “E”.

The data are accessed and modified with the “Enter” and *arrow* keys, etc. following the normal rules applied to all the menus (see an example in par. 6.1.3).

Another special function is available: holding down “Enter” [Enter] for three seconds makes a copy of the timer on which you are positioned; moving to another timer and holding down “OK” [OK] for three seconds pastes the whole configuration of the first timer onto this one; the operation is then confirmed by pressing “OK” [OK] or cancelled by pressing “ESC” [ESC].

This special function makes it particularly easy to repeat the data of a timer if you want to change, for example, only one parameter, such as the day or the setpoint.

If you want a timer to be activated every day, clearly it is sufficient to mark the boxes of all seven days of the week for that timer.

The possibility of enabling or disabling a timer may be useful, for example, at the change of season, allowing you too exclude a timer but leaving all its data set to be used again later.



If two or more timers have been programmed as “active” at the same time, the one that comes first in alphabetical order will have precedence, that is Timer A will have precedence over Timer B and so on.

6.2.5.2 *Timer daily summary*

The set timers are displayed like a chrono-thermostat: the profile of the set points used as a function of the time is shown for each day of the week. This offers an immediate check of the operation of each whole day.

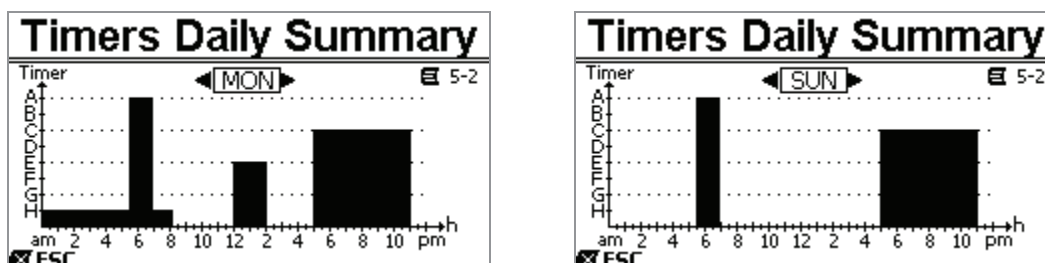

Figure 32

6.2.6 External Control

The machine can be controlled by an external control unit or by a PC.

To use this mode, see also paragraphs 5.1.2 and 5.4.

This function is set by means of this sub-menu, which considers separate items for inputs and outputs.

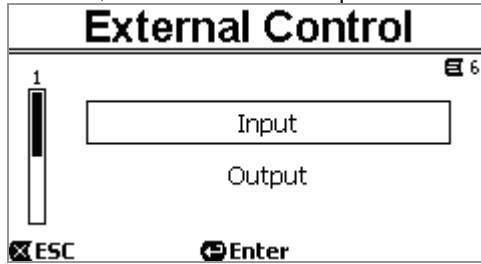

Figure 33

This function is disabled and not configured when the system leaves the factory. The electrical characteristics of the inputs and outputs are given in paragraph 2.3.

6.2.6.1 Configuration of the Inputs

The inputs are configured from this menu page.

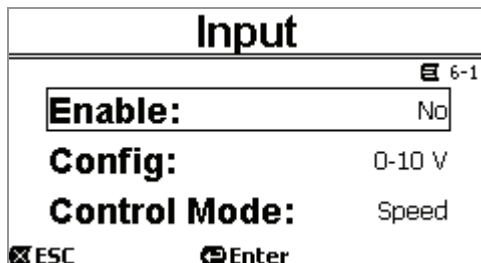

Figure 34

From this item, you first set the general enabling of “EXT External Control” mode.

The inputs include:

- a digital input for the START/STOP control;
- an analog input, through which the setpoint to be activated is communicated.

The analog input can be selected “in volgage 0-10 V” or “in current 4-20mA”.

The setpoint to be activated can be chosen for regulation by *Flow* or regulation by *Speed %* (see paragraph 5.1.1.)

6.2.6.2 Configuration of the Outputs

A relay output (clean contact), normally open, is available.

It can be configured to signal:

- the running status (“RUN”) → When the pump is running the contact closes, and it remains open when the pump is stopped.
- the system block status (“FAULT”) → In the case of blocking errors the contact opens, whereas it remains closed when faults are absent.

The outputs are configured from this menu page.

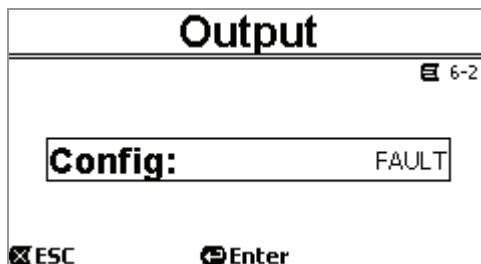

Figure 35

6.2.7 Priming

Each time the pump starts, the system performs the priming procedure (if enabled).

Priming consists of two phases:

- At the end of pump startup (as described in par. 5.2), the flow is checked; if it regular, Priming has already been completed and it passes to the conditions of the active setpoint.
- If this is not the case, the system has discharged and must be primed again: it now enters the second phase, where the pump is activated at *Maximum Priming Speed*, until it is primed or at any rate for all the time specified by the parameter “*Max Priming Time*”.

Here too, if priming has been successful, it proceeds regularly according to the active setpoint.

But if priming has not been successful, it goes into “*NoPriming*” fault status (block). On blocks and resets, see chapter 7.

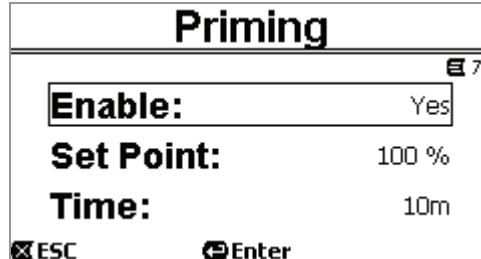

Figure 36

The “*Priming*” item on the menu allows you to:

- enable or disable the function (factory value: enabled);
- select “*Max Priming Speed*”, between 50% and 100%;
- select “*Max Priming Time*”, between 1 and 30 minutes.

The factory values are given in chapter 8.



In installations below water level, it is not generally necessary to perform Priming each time the pump is started (and it can be disabled).

*The maximum speed during priming (“*Max Priming Speed*”) can be reduced in the case of systems that are not able to withstand high speeds.*

6.2.8 Antifreeze (Protection against water freezing in the pump)

As is known, the formation of ice, that is the change of state of water from liquid to solid, causes an increase in volume, with the risk of breakages for the systems containing water.

For this reason it is generally recommended to empty any pump and hydraulic system during winter, when the temperatures are close to freezing point.

However, our system is equipped with the “*Antifreeze*” function, which automatically rotates the pump if the temperature falls to values close to zero. The water inside the pump is thus kept moving and slightly heated, thus limiting the risk of the formation of ice.



This function protects the pump, but it cannot generally prevent the formation of ice in the swimming pool or in other parts of the system.

The temperature sensor is fitted close to the motor and does not directly feel the water temperature, but that of the pump motor assembly.

If the pump is in a technical room, the outdoor temperature may be lower, even much lower, than the one measured by the sensor.



ATTENTION: The *Antifreeze* protection works only as long as the system is regularly powered: with the electric power disconnected or in the absence of current (even accidental, such as after a blackout) the protection cannot work. So it is advisable not to leave the system loaded during periods of inactivity in winter, but empty it accurately.



In cases of long inactivity, it is advised not to disconnect the electric power to keep the *antilock* protection active (see the following paragraph).



The intervention of the Antifreeze function turns the pump even if the system is in STOP status (white led  blinking), and is not influenced by the active operating mode (manual or automatic).

If you want to prevent the Antifreeze function intervening and turning on the motor, the function must be disabled.

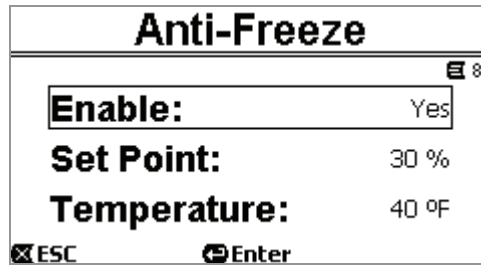

Figure 37

The “*Antifreeze*” item on the menu allows you to:

- enable or disable the function (factory value: enabled);
- select the pump rotation speed during the intervention of *Antifreeze*: between 20% and 100%;
- choose the intervention temperature of *Antifreeze*, between 4°C and 10°C (between 40°F and 50°F).

The factory values are given in chapter 8.

6.2.9 Anti-Lock (Protection against mechanical blocking of the pump)

This function prevents mechanical blocks occurring in the case of long inactivity; it acts by periodically turning the pump, at a very low speed that does not create a head.

When the function is enabled, the pump performs an unlocking cycle lasting a few seconds every 23 hours (elapsed without any start of the pump).

The “*Antilock*” item on the menu allows you to enable or disable the function (factory value: enabled).



ATTENTION: The *Antilock* protection works only as long as the system is regularly powered: with the electric power disconnected or in the absence of current (even accidental, such as if the automatic switches have blown due to a storm) the protection cannot work.



The intervention of the Antilock function turns the pump even if the system is in STOP status (white led blinking), and is not influenced by the active operating mode (manual or automatic).

If you want to prevent the Antilock function intervening and turning on the motor, the function must be disabled.

6.2.10 Fault History

This item on the menu allows you to consult the fault history and erase it.



Figure 38

Press “*ENTER*” on the second item to erase the list.

Instead, if you press “*ENTER*” on the first item, it gives access to the list of faults in the memory, which you can scroll through with the arrow keys (not indicated on the display).



Figure 39

The faults are shown in chronological order, starting from the most recent one, up to the one that occurred farthest back in time. The list is scrolled with the up arrow and down arrow keys.

The maximum number of faults that can be stored and displayed is 16; when this number is reached, the list starts to overwrite the oldest ones.

7 PROTECTION SYSTEMS – LOCKS (FAULT)

The device is equipped with protection systems to preserve the pump, the motor, the supply line and the inverter. If one or more protections trip, the one with the highest priority is immediately notified on the display.

Faults cause switching off of the motor and lighting of the red warning LED (⚠).

In some types of fault, the motor restarts as soon as normal conditions are restored; in others, attempts at automatic reset are carried out after a certain space of time.

It is also possible to try to cancel the error condition manually (see the following paragraphs).

If the error condition remains, you must take steps to eliminate the cause of the fault.



In system fault condition, with the red LED (⚠) lit, the keys “SET1-4” or “QuickClean” are not accepted; however, if one them is already active, it remains.

Fault No.	Description on the display
e1 / e14	Internal error
e15	Motor phases short circuit
e16	Short circuit to earth
e17 / e19	Internal error
e20 / e22	Electronic excess temperature
e23	Low mains voltage
e24	High mains voltage
e25	Motor excess temperature
e26	Motor blocked
e27	Dry operation
e28	Pump not primed
e29	No current
e31	Internal error

Table 5 – List of Faults

7.1 Manual reset of error conditions

In block (fault) status, the user can cancel the current error and force a new attempt by pressing and releasing the “Reset” key.

If the action is successful, the red warning LED (⚠) goes out and the system returns to normal operation.

Instead, if the error condition remains, you must take steps to eliminate the cause of the fault.

7.2 Automatic reset of error conditions

For some types of fault, automatic reset attempts are contemplated.

In particular for:

- e27 Dry operation
- e28 Pump not primed

a new attempt is made after a few minutes, and repeated cyclically.

If an attempt is successful during the reset sequence, the sequence is interrupted, the red warning LED (⚠) goes out and the system returns to normal operation.

In the case of the “Excess temperature” faults, the system resume operation as soon as the temperature returns within the normal operating range.

7.3 Viewing the block history

The list of the faults and blocks that have occurred most recently can be consulted under the menu item “Fault History”. See paragraph 6.2.9.

8 FACTORY SETTINGS

The system leaves the factory with a series of preset parameters, which may be changed according to the requirements of the plant and of the user. Each change of the settings is automatically saved in the memory. The factory (or default) settings are summed up in the following table. You can make a note of the values modified for your own installation in the "MEMO" column.



As indicated in the table, some default values may differ depending on the market for which the system is intended.

If desired, it is possible to restore the default settings, proceeding as described in paragraph 8.1.

Factory settings					
Menus	Function	Parameter	Value (*)		MEMO
1-2	Language		English		
1-3	Time format		24h	AM PM	
1-4	Unit of Measure	Head Unit	m (metres)	ft (feet)	
		Flow Unit	m ³ /h	US GPM	
		Temperature Unit	°C	°F	
1-5	Pump Limits	H max (head)	MAX		
		Q max (flow)	MAX		
1-6	Screen	Sleep Time	1:00 h		
1-7	Password	value	0 (not active)		
2	Set Points 1-4	type of setpoint	Speed %		
2	SET1	setpoint Q	5 m ³ /h	20 GPM	
		setpoint %	50%		
		duration	ENDLESS		
2	SET2	setpoint Q	12 m ³ /h	50 GPM	
		setpoint %	70%		
		duration	ENDLESS		
2	SET3	setpoint Q	18 m ³ /h	80 GPM	
		setpoint %	85%		
		duration	ENDLESS		
2	SET4	setpoint Q	25 m ³ /h	110 GPM	
		setpoint %	100%		
		duration	ENDLESS		
3	Set Points 5-8	type of setpoint	Flow		
3	SET5	setpoint Q	5 m ³ /h	20 GPM	
		setpoint %	50%		
3	SET6	setpoint Q	12 m ³ /h	50 GPM	
		setpoint %	70%		
3	SET7	setpoint Q	18 m ³ /h	80 GPM	
		setpoint %	85%		
3	SET8	setpoint Q	25 m ³ /h	110 GPM	
		setpoint %	100%		
4	Quick Clean	setpoint	100%		
		duration	10 min		
7	Priming	function	enabled		
		Max Priming Speed	100%		

ENGLISH

		<i>Max Priming Time</i>	10 min	
8	Anti-Freeze	function	enabled	
		<i>speed</i>	30%	
		<i>temperature</i>	4 °C	40 °F
9	Anti-Lock	function	enabled	
(*) Factory value on some markets				

Table 6 – Factory (default) settings

8.1 Restoring the factory settings

To restore the factory values, switch off the device, wait until the display has switched off completely, press and hold down simultaneously the two keys “SET1” and “SET4” and turn on the power; release the keys only when the messages appear on the display.

This restores the factory settings (consisting of a message and a rereading on EEPROM of the factory settings permanently saved in the FLASH memory and listed in the table above).

Once all the parameters have been set, the device returns to normal operation.



NOTE: this operation obviously deletes all the parameters that have previously been modified by the operator.

Once the factory values have been restored, it will therefore be necessary to reset all the parameters that characterise the system, as at the first installation: for the sake of convenience, the system again proposes the WIZARD (paragraph 4.2).

9 TROUBLESHOOTING

- The pump does not start (display off):
No electric power.
Check that there is voltage and that the connection to the power network is correct.
- The pump is not sucking:
No water in the prefilter or clogged prefilter.
Closed valve in the pipes.
Air getting into the suction pipe.
- The motor is not working:
The electric power supply or switch are turned off.
Motor electrical connections are faulty.
Impeller blocked by foreign bodies, shaft not turning.
- Noisy pump:
Air getting into the suction pipe.
Presence of foreign bodies in the pump body.
Cavitation.
Ball bearing damaged.
- Low flow rate: low pressure in the filter.
Basket or impeller clogged.
Air getting into the suction pipe.
Motor turning in the opposite direction.
- Low flow rate: high pressure in the filter.
Delivery pipe choked.
Inadequate section of the power supply cables.
Pump filter clogged.

10 MAINTENANCE



Disconnect the power supply before starting any work on the system.

The system requires no routine maintenance operations.

Periodically inspect and clean the pump filter.

We suggest special maintenance at least once a year by qualified personnel.

11 DISPOSAL

This product or its parts must be disposed of in an environment-friendly manner and in compliance with the local regulations concerning the environment. Use public or private local waste collection systems.

12 GUARANTEE

Any use of faulty material or manufacturing defects of the appliance will be eliminated during the guarantee period contemplated by the law in force in the country where the product is purchased, by repair or replacement, as we decide.

The guarantee covers all substantial defects that can be assigned to manufacturing faults or to the material used if the product has been used correctly, in accordance with the instructions.

The guarantee is void in the following cases:

- attempts to repair the appliance,
- technical alterations to the appliance,
- use of non-original spare parts,
- tampering,
- inappropriate use, for example industrial use.

Excluded from the guarantee:

- parts subject to rapid wear.

When making a request under guarantee, apply to an authorised technical assistance service, presenting proof of purchase of the product.